

STAINLESS METAL CRAFT

6 BROMLEY ROAD EMU PLAINS 2750
PHONE: (02) 4735 5666 FAX: (02) 4735 7950
E-MAIL info@smcstainless.com.au
www.smcstainless.com.au

THE STAINLESS STEEL PEOPLE

(SINCE 1962)

MATERIAL - GRADE 304 STAINLESS STEEL

PAPER TOWEL DISPENSER

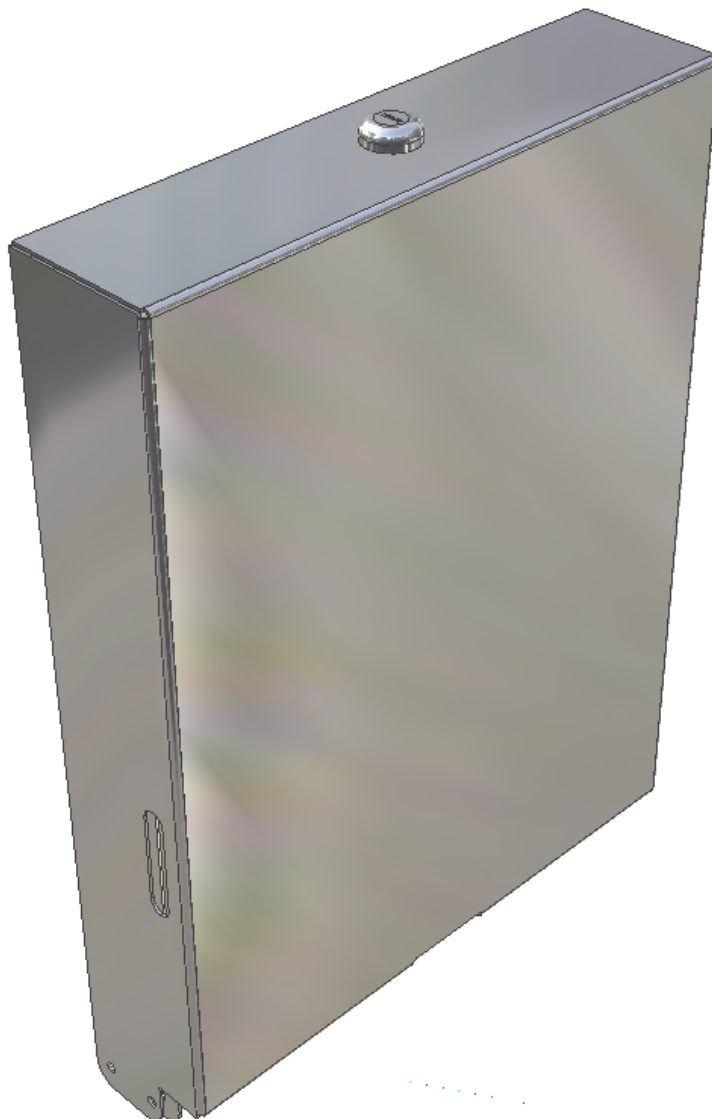

* TYPICAL USE :
- PAPER TOWEL DISPENSER - SLIM LINE - LOW MAINTENANCE -
- HIGH VANDAL RESISTANCE

* PUBLIC AMENITIES eg COMMERCIAL BUILDINGS / COUNCIL / RAILWAY STATIONS
* SHOPPING CENTRES / SCHOOLS / INDUSTRY / CLUBS / HOTELS

**DATA
SHEET**

ITEM: PAPER TOWEL DISPENSER

CODE: PTD-4-SM

DATE:

MARCH - 2003

REV:

C

PAGE No:

88

STAINLESS METAL CRAFT

6 BROMLEY ROAD EMU PLAINS 2750
PHONE: (02) 4735 5666 FAX: (02) 4735 7950
E-MAIL info@smcstainless.com.au
www.smcstainless.com.au

THE STAINLESS STEEL PEOPLE

(SINCE 1962)

MATERIAL - GRADE 304 STAINLESS STEEL

- * - SURFACE MOUNTED
- * - SUITABLE FOR MOST TYPES OF INTERLEAF TOWEL

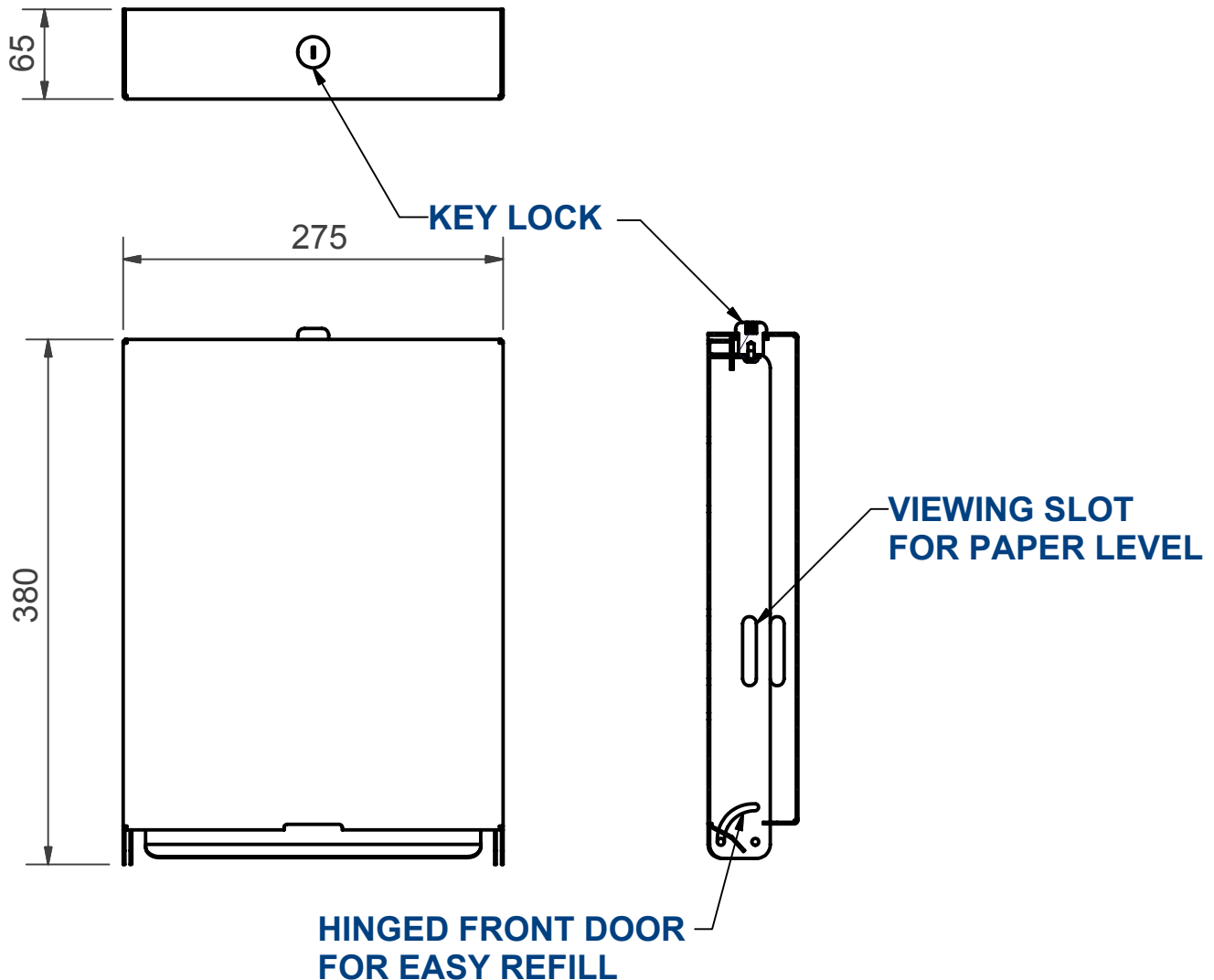

SPECIFICATIONS -
STAINLESS STEEL PAPER TOWEL DISPENSER
SHALL BE MODEL PTD-4-SM FROM
STAINLESS METAL CRAFT
PHONE: 02 9756 4977

DATA SHEET

ITEM: PAPER TOWEL DISPENSER

CODE: PTD-4-SM

DATE:

MARCH - 2003

REV:

C

PAGE No:

88